

Annual Report by the Neighborhoods Commission
August 31, 2010

D6 Annual Report

District 6 Neighborhood Associations

**your D6
Commissioners:**

- Richard Allen
- Larry Ames
- David Dearborn

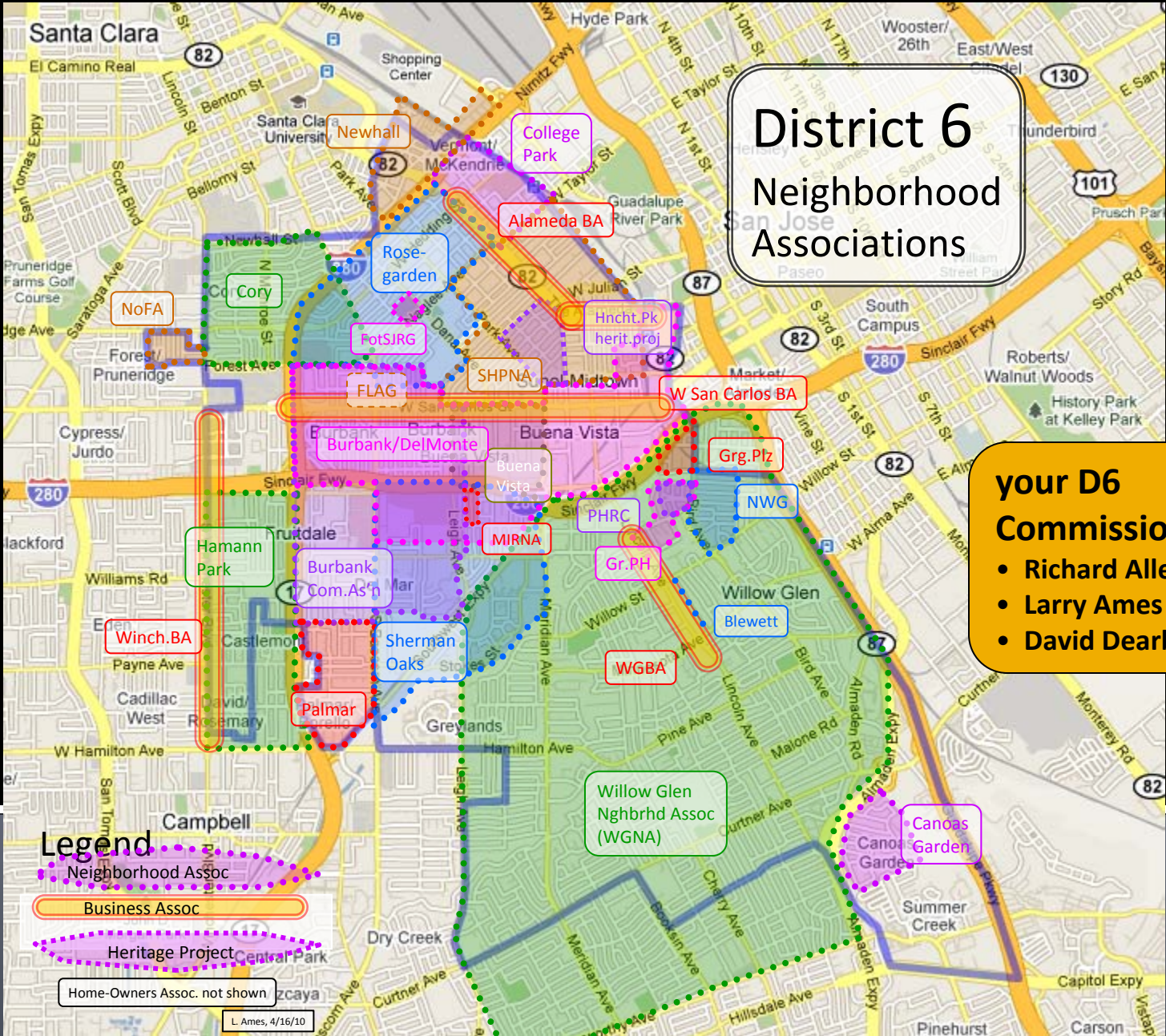

Our Mission

- Integrate the voice of the neighborhoods into the City's decision-making processes
- Study issues, courses of action, policies and programs that affect neighborhood quality of life
- Make recommendations to the Mayor, City Council and Redevelopment Agency
- Empower the neighborhoods

History

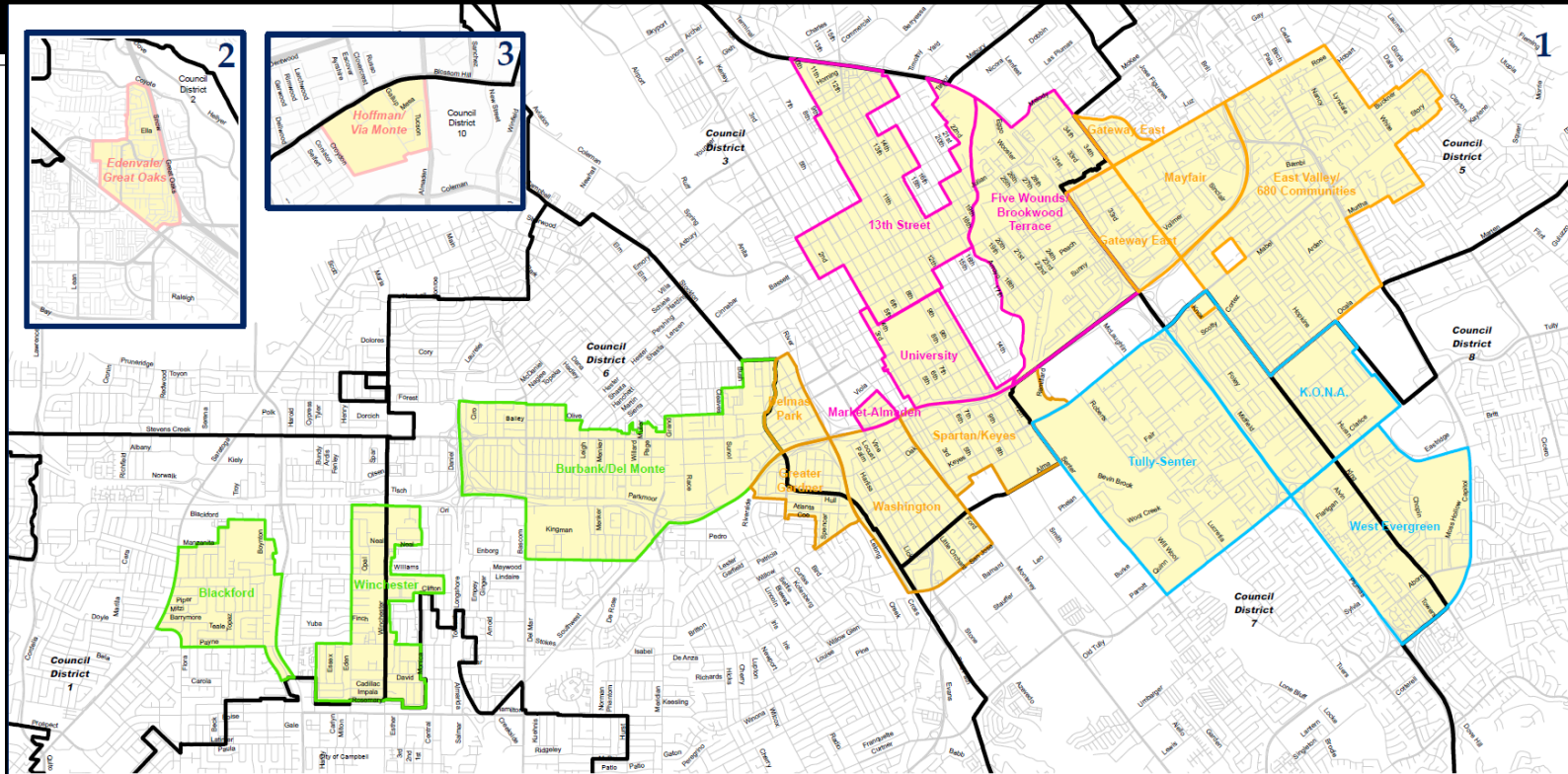

- 2002: Strong Neighborhood Initiative (SNI) to assist ~1/3rd of city
- 2007 (→'08): SNI Project Advisory Committee (PAC) “sunsetted”. SNI PAC recommended continuing community/City dialog, involving whole city → the Neighborhood Commission
- 2007 Mock Caucuses
- mid 2008: Caucuses. (D6's was 6/7/08)
- about 1 yr delay in seating (City had to survey self to find all the other Commissions to avoid overlap) → First meeting: Wednesday, July 8, 2009

Relationship to D6NLG, UNSCC, ...

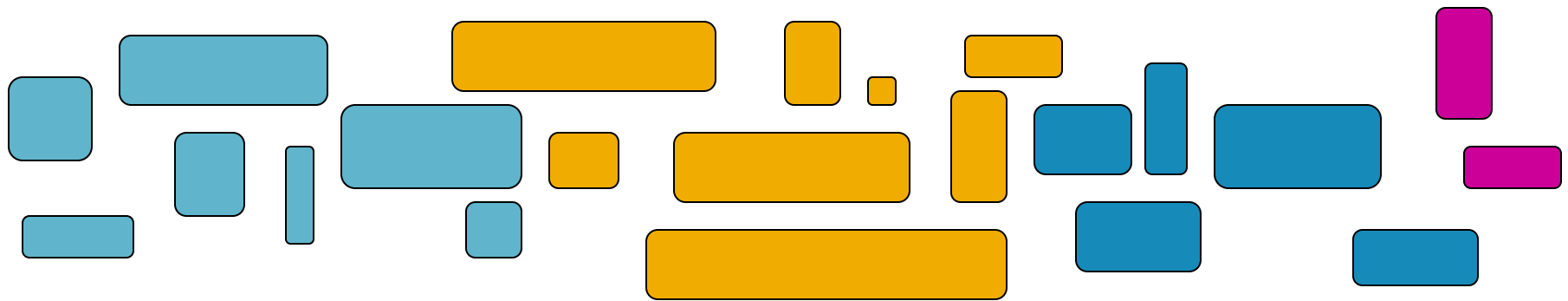

neighborhood groups, large and small, across the city

Relationship to D6NLG, UNSCC, ...

groups within a district
meet to discuss regional issues
(e.g., in-fill and stadium for D6NLG),
and to informally share ideas

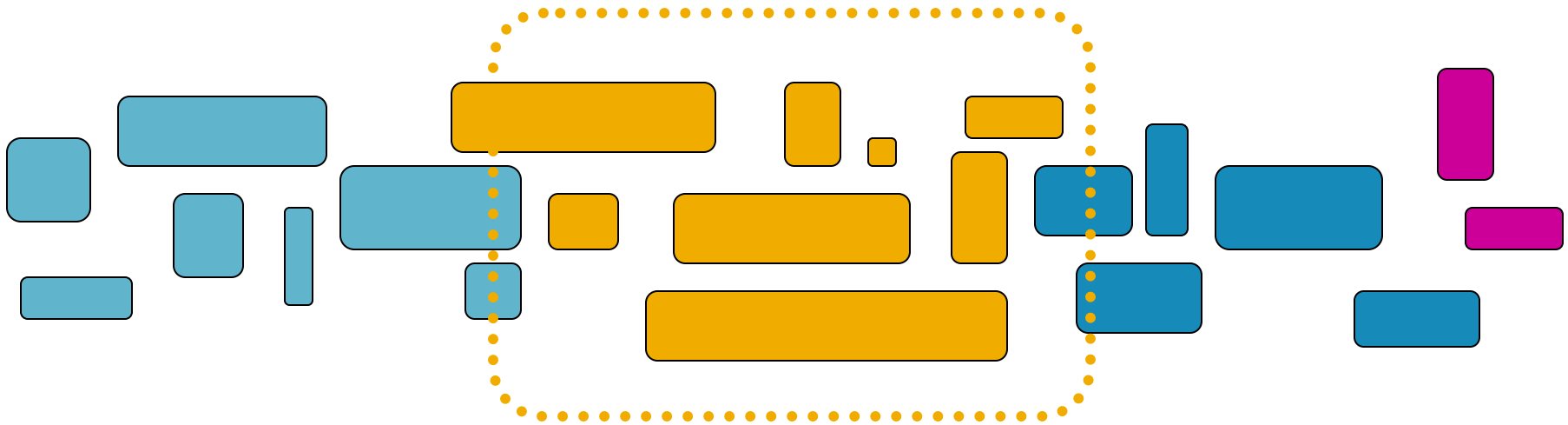

Relationship to D6NLG, UNSCC, ...

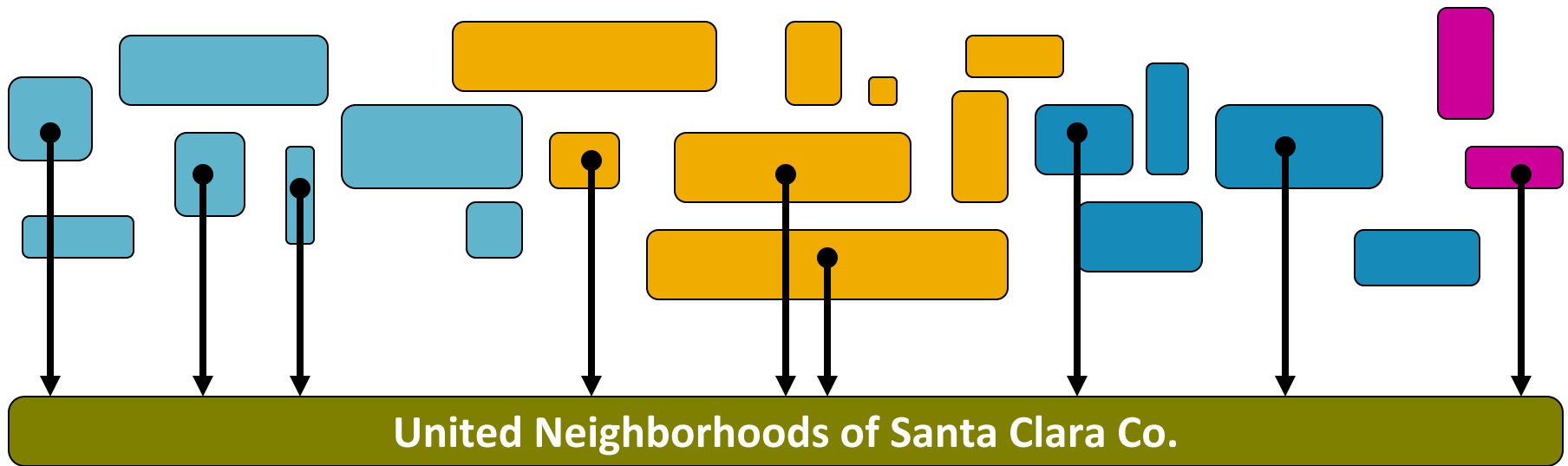

United Neighborhoods of Santa Clara Co.

groups from across the County may participate in UNSCC
to learn techniques and share insurance & 501(c)3 funding

Caucus Process

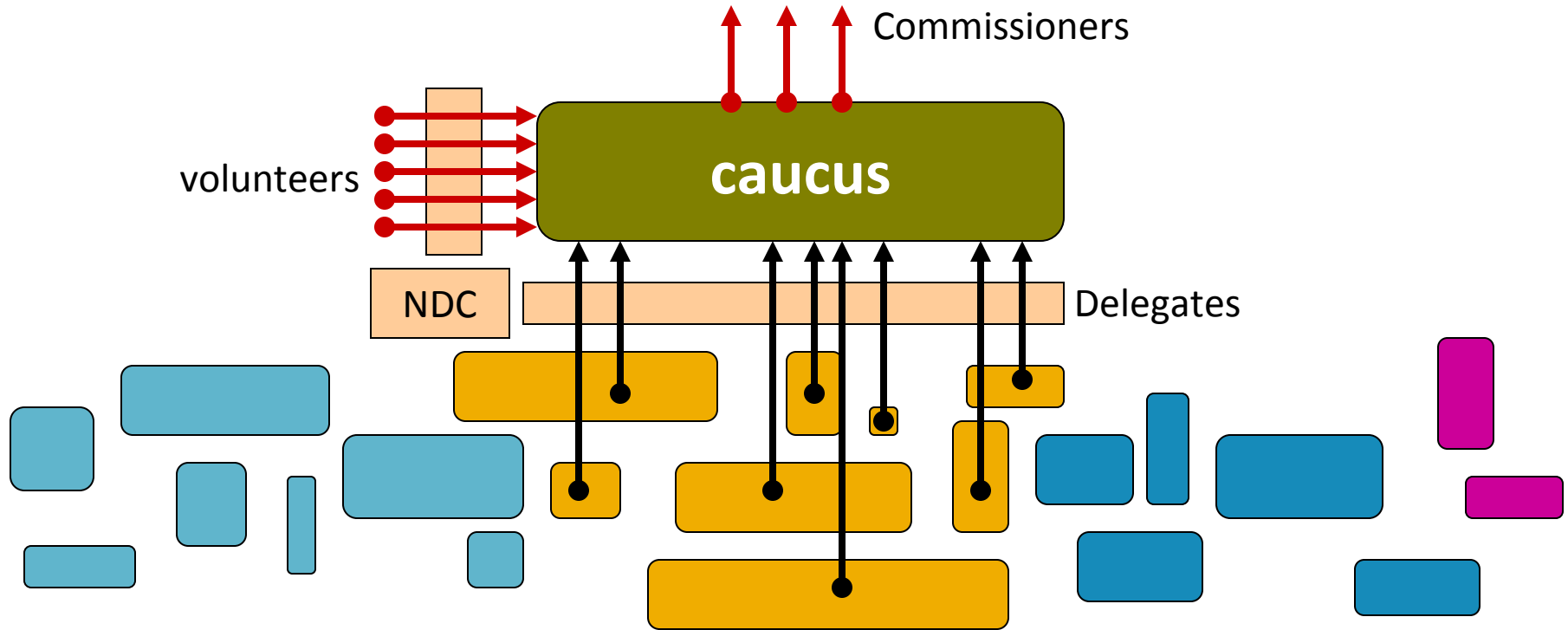

Standard Relationship to City

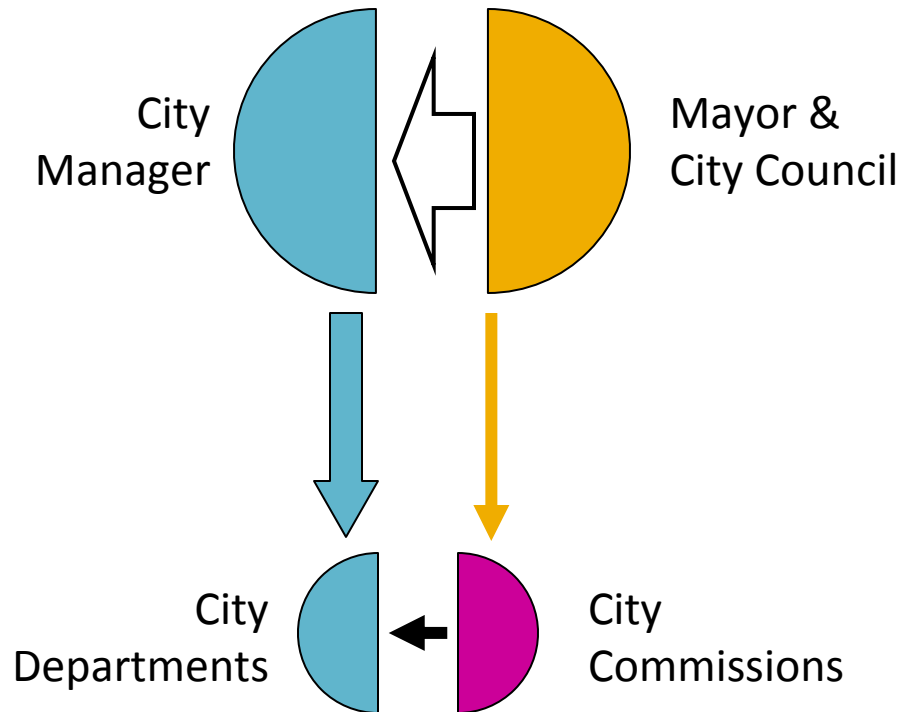

Nghbrhd Cmsn Rel'ship to City

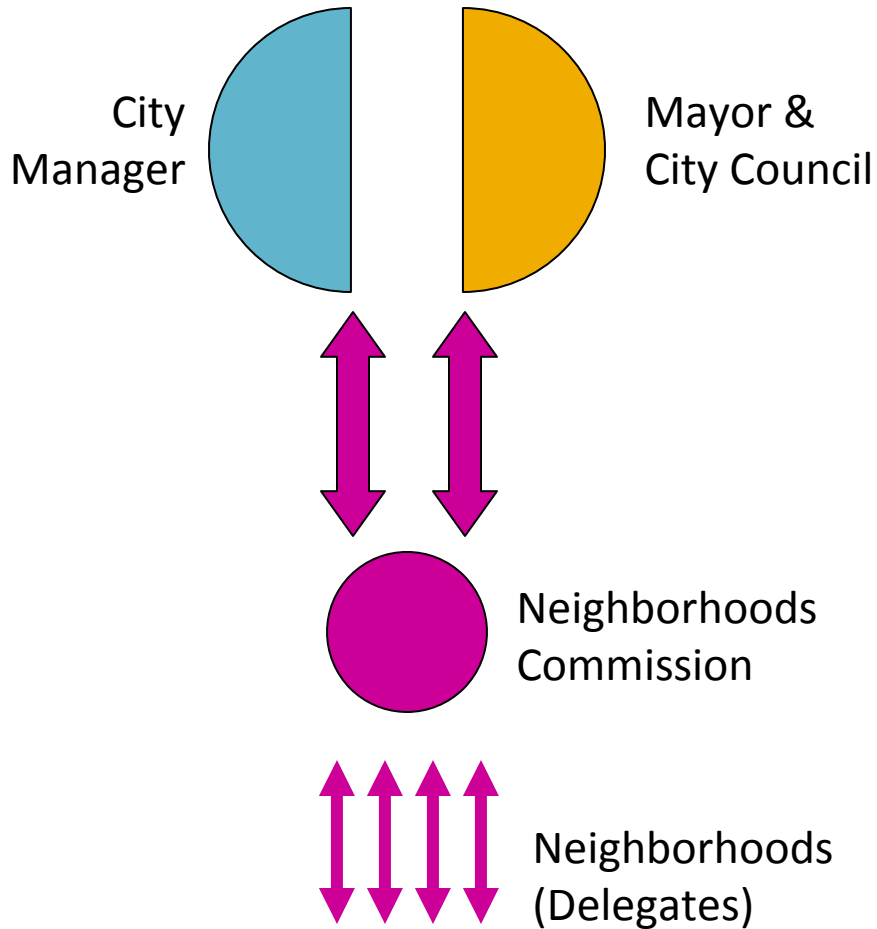

Work Plan

- Budget Alignment
 - Integrate and align neighborhood priorities with the City's budget priorities
- Communications and Outreach
 - Increase the ability of neighborhood associations to better communicate with the City and each other
- Civic Engagement
 - Increase the ability of San Jose residents to better understand and participate in the City's government

Accomplishments

- Approved Work Plan for 2009-2010
- Budget recommendations
 - Recommendation letter to Mayor & City Council
 - Stressed the link between community services and public safety
- Community Policing recommendation
 - Met with Chief of Police and Acting Independent Auditor
 - Discussed options
 - Recommended a longer rotation period
 - Additional study and recommendations forthcoming

What Should Our Focus Be?

- Public Safety
 - Link between public safety and community services
 - Community policing
- Civic Engagement
 - Outreach Policy 6-30
- Quality of Life Issues
 - Trees and tree maintenance
 - Land-use issues (Greenprint; Envision 2040)

Next Year

- 2-year “Trial Program”
- Commissioners have staggered 2-year terms
- if Commission is renewed, will have caucus next year to select new Commissioners or reapprove current Commissioners.
- Neighborhood Commission Caucus Cmte and Neighborhood Development Center (NDC) will start process months in advance, to allow Neighborhood Associations time to select delegates

Question or comments?

Neighborhoods Commissioners

■ Charles E. Jones	1
■ Lori Lynn Kahn	1
■ Ed Brooks	1
■ Vacant	2
■ Marie Cecilia Arnold	2
■ Manuel Souza	2
■ Beth R. Shafran-Mukai	3
■ Jaime A. Angulo	3
■ Mauricio Astacio	3
■ Linda Locke	4
■ Rafael Sabic	4
■ David J. Biagini	4
■ Elsie Lara Aranda	5
■ Vacant	5
■ Vacant	5

Neighborhoods Commissioners

■ David D. Dearborn	6
■ Larry Ames	6
■ Richard Allen	6
■ Berth Ward	7
■ Roberto C. Sandoval	7
■ Moses Chavez Ramirez	7
■ Thomas M. Paramo	8
■ Neetu Dhaliwal	8
■ Matthew W. Wahlin	8
■ Hugh Graham	9
■ Melisa McCoy –Evans	9
■ Jim Ramsell	9
■ Robert E. Boydston	10
■ Russell J. Petruzzelli	10
■ Vacant	10

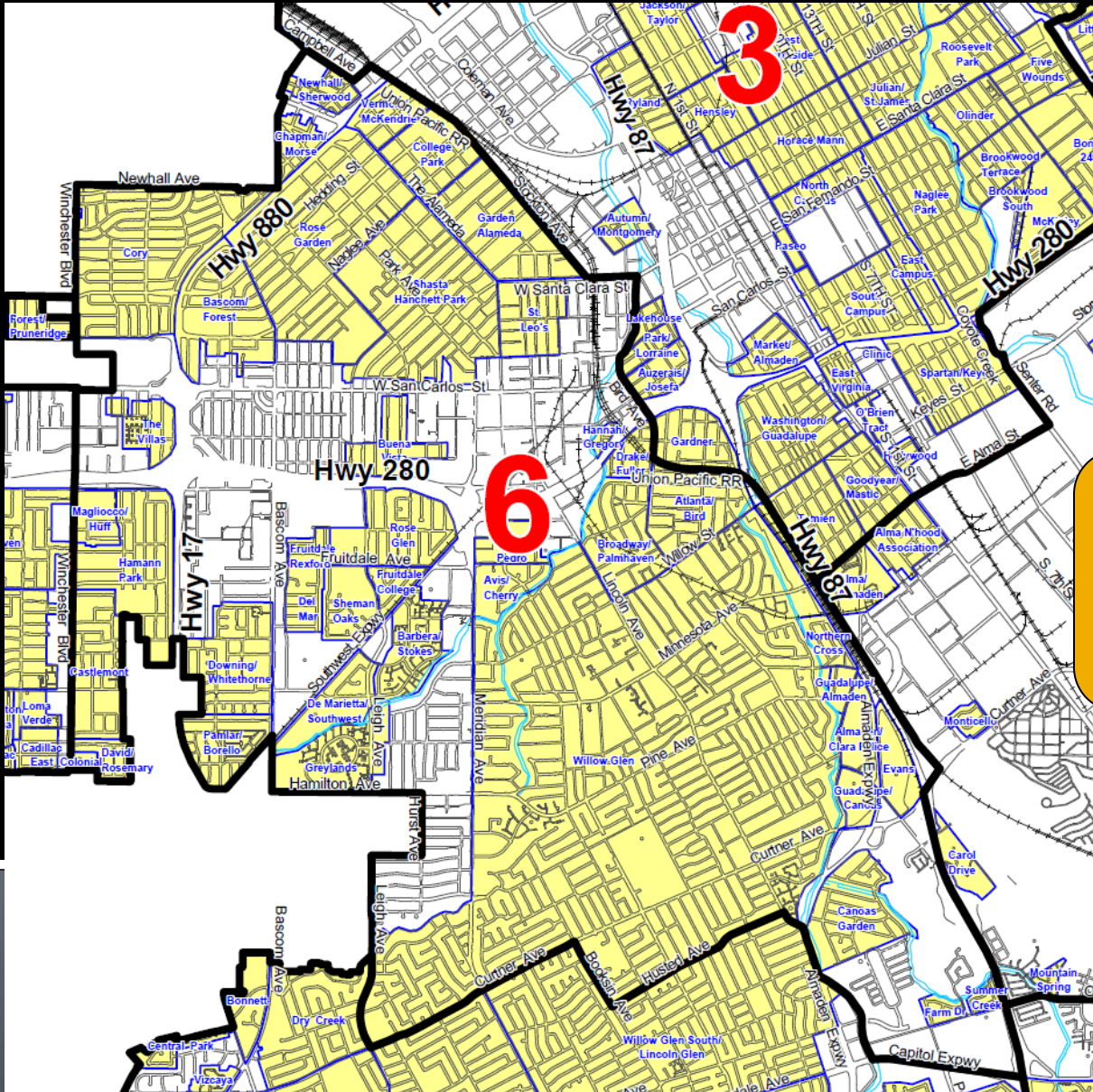

**your D6
Commissioners:**

- Richard Allen
- Larry Ames
- David Dearborn